

FEATURES OF REGULATIONS AND CALCULATION OF OVERHEATING FROM SOLAR RADIATION BY USING SOLAR MAPS

O.V. Sergeychuk¹ O.V. Andropova¹ Y.V. Kozak¹ E.N. Scherbakova²

1. Department of Architectural Constructions, National University of Construction and Architecture, Kiev, Ukraine
ovsergeich@i.ua, andropova.ov@knuba.edu.ua, kozak.iuv@knuba.edu.ua

2. Department of Labour Protection and Environment, National University of Construction and Architecture, Kiev, Ukraine, elenym111@gmail.com

Abstract- To limit summer overheating of premises from impact of solar radiation, it is necessary to use massively sun shading devices (SSD). Correctly designed SSD can significantly reduce the load on the cooling systems of buildings in overheating while maintaining (or insignificantly reducing) passive solar heating in winter. Unfortunately, it is problematic for engineer how to find the correct solution design them. One of the reasons for this is the lack of a simple and visual tool that would allow estimating quickly the effectiveness of the designed SSD. Upgraded solar maps can become such a tool.

Keywords: Insolation, Solar Devices, Solar Maps, Energy Efficiency, Solar Energy.

1. INTRODUCTION

The design and construction of NZEB buildings is the most important economic and environmental task of our time. In [1], the directions for solving this problem are considered and the need for maximum passive use of solar energy is indicated to create comfortable indoor conditions with minimal additional energy consumption for building climate control. This is especially true for regions with hot climates, for example, the South of Ukraine, Azerbaijan, where cooling of buildings in summer is a mass phenomenon. It is necessary to use massively sun shading devices (SSD) to limit summer overheating of premises from impact of solar radiation. Correctly designed SSD can significantly reduce the load on the cooling systems of buildings in overheating while maintaining (or insignificantly reducing) passive solar heating in winter. [2, 3].

A lot of research has been devoted to the problem of determining SSD effectiveness. In [4] the influence of three types of stationary sun protection devices (cellular, vertical and diagonal) on the reduction of overheating in rooms oriented to the south-west in hot climates is studied. The conclusion is made about the correctness of using diagonal sun-protection devices for the south-western orientation of the facades, but no methodology for their design is proposed. The source [5] proposes a matrix to select the most suitable natural light system during design.

This matrix can be considered as a general approach in the design of SSD, but it requires specification depending on climatic conditions. Article [6] is devoted to the optimization of perforated solar screen (percentage of perforation, matrix shape and cell size) depending on the orientation of the facade in Spain. The importance of the correct choice of the SSD geometry is shown, but specific recommendations for its optimization are not given. The article [7] considers methods for designing stationary sun shading devices based on three methods:

1. using solar maps,
2. using horizontal and vertical shadow angles,
3. based on the daily cone of sunlight.

This is only an overview article and does not address specific recommendations. In [8], the possibility of designing optimized sun protection devices based on the use of solar maps is shown, but the proposed technique needs to be improved. In Europe, a standard has been adopted for calculating the duration of insolation [9] and a method for calculating the characteristics of sunlight and daylight for sun protection devices combined with glazing [10].

In [11] a peculiarity of the early stage of building design is analyzed. It is proved that at this stage it is impossible to use software based on the detailed characteristics of the engineering systems of the building. Existing standards and methodologies are not designed to quickly search for a rational SSD geometry at the stage of preliminary design of buildings, when the basic concept of using solar energy is accepted. It is important for the architect to clearly see, in one drawing, how the insolation regime of the room changes during the year: whether the sun enters the volume of the room in winter and whether there is no overheating in summer. Therefore, the main tools for the design and calculation of sun protection devices are still solar maps, which were proposed in the I century BC by M. Vitruvius [12, 13], known as Vitruvian Analemma Figure 1, a. Since then, they have been changed to a certain extent Figure 1b, remaining almost the same in principle [14, 15].

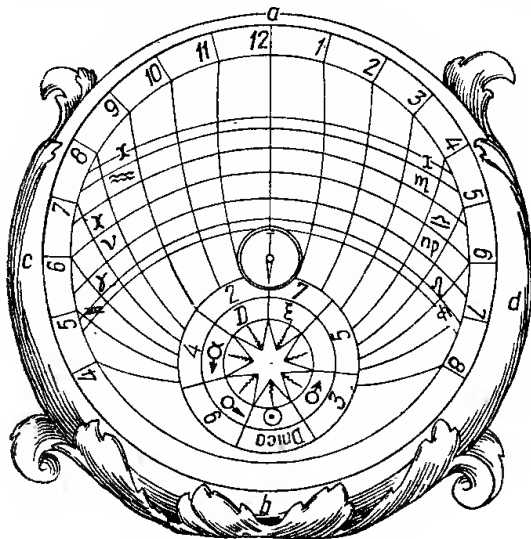

(a)

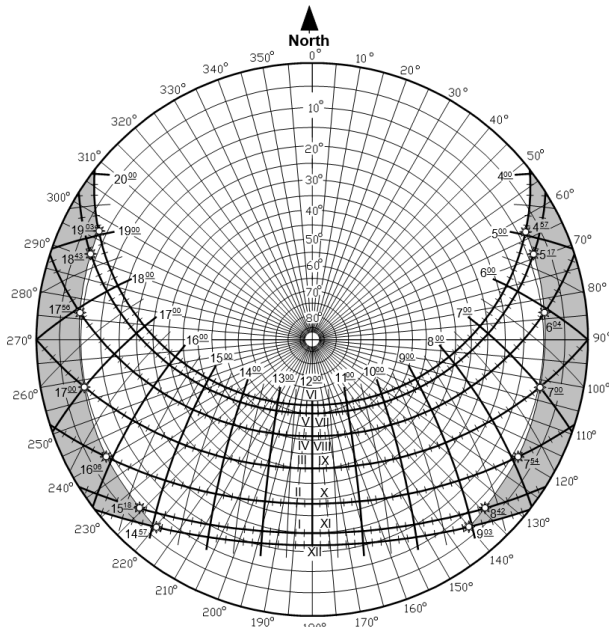

(b)

Figure 1. Solar maps: (a) Vitruvian Analemma, "Rudimenta Mathematica" [13], (b) Solar map for 50°N [14]

The analysis of solar maps allowed in [14] to present a diagram of the choice of the type of sun shading devices depending on the orientation of the facade for the middle latitudes of the northern hemisphere Figure 2.

This scheme considers the following types of stationary SSD:

- Horizontal - in which the shading elements are located horizontally.
- Vertical - in which the shading elements are located vertically.
- General Position - in which the shading elements are located at an angle to the projection of the aperture.
- Combined - consisting of two or more systems of shading elements of different positions. Cellular structures consisting of vertical and horizontal elements can be considered as combined SSD.

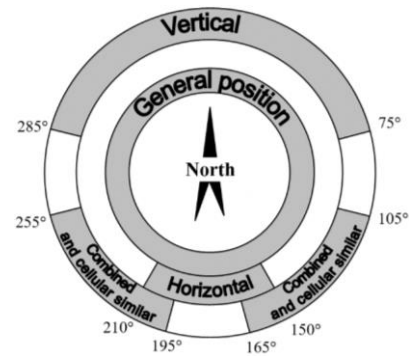

Figure 2. Recommendations for the use of different types of SSD with different orientations of the facade [14]

This diagram takes into account only the daily course of sunlight and does not allow optimizing the geometry of the SSD, taking into account the peculiarities of the climate in a particular construction region.

2. PURPOSE

The goal of this research is the development of graphical tools, would allow engineers to design rational geometry of sun shading devices depending on the climatic conditions of the construction region and facade orientation of a designed building. After that, the energy efficiency of this SSD can be analyzed.

3. RESULTS

Ukrainian standards propose [14] modified solar maps, on which isotherms are plotted indicating acceptable and unacceptable insolation zones. The zone of unacceptable insolation is sky zone, in which the air temperatures is over 21 °C; an acceptable insolation zone is one with temperatures under 8 °C. Plotting isotherms of these air temperatures on solar maps turns them into complex solar maps.

To plot isotherms, it is sufficient to have the values of the average monthly air temperatures and the average daily amplitudes of their fluctuations for each month of the specific year. These data, as a rule, are given in the national standards for building climatology [16, 17]. It is known that the minimum daily air temperature value occurs approximately, 15 minutes after sunrise, with maximum value being at 3:00 p.m. [18, 19].

In [20], there was proposed a method for modeling the function of changing a periodic climatic parameter, which has one maximum and one minimum within the period, based on values of its extrema by using sinusoidal functions. The function of changing air temperature during the day t_h , according to this method, has the form [16]:

$$t_h = \frac{A}{2} \times \sin \left[\frac{\pi}{2} \times \frac{2x - 3T_{\min} - 9}{9 + T_{\min}} \right] + t, \text{ where } 0 \leq x < T_{\min}$$

$$t_h = \frac{A}{2} \times \sin \left[\frac{\pi}{2} \times \frac{2x - 15 - T_{\min}}{15 - T_{\min}} \right] + t, \text{ where } T_{\min} \leq x < 15 \quad (1)$$

$$t_h = \frac{A}{2} \times \sin \left[\frac{\pi}{2} \times \frac{2x - 21 + T_{\min}}{9 + T_{\min}} \right] + t, \text{ where } 15 \leq x < 24$$

where, A is average daily amplitude of average monthly air temperature, °C; t is average monthly air temperature, °C; T_{\min} is the time of the onset of the minimum air temperature during the day, which took 0.25 hours after sunrise, hours; x is local time, hours.

By using this formula for the 15th day of each month, it is possible to build a frame of the temperature surface as functions of the day of the year and the time of the day. After that the temperature surface is constructed by using interpolation

The isolines of temperatures for 8 and 21 °C are located on it. These isolines are transferred to the solar map for the corresponding latitude of the region as result the complex solar maps are created.

The T_{min} value with a sufficient precision for practical needs can be determined with the appropriate solar map by using the formula:

$$T_{min} = 0.2T_{sunrise\ i} + 0.8T_{sunrise\ i+1} + 0.25 \tag{2}$$

where, $T_{sunrise\ i}$ is sunrise time along the trajectory of the calculated month, hour; $T_{sunrise\ i+1}$ is time of sunrise along the trajectory for the next month after the calculating month, hour.

For example, Figure 3 shows a considered construction of a complex solar map of Kiev, Ukraine. These calculations were made in Excel.

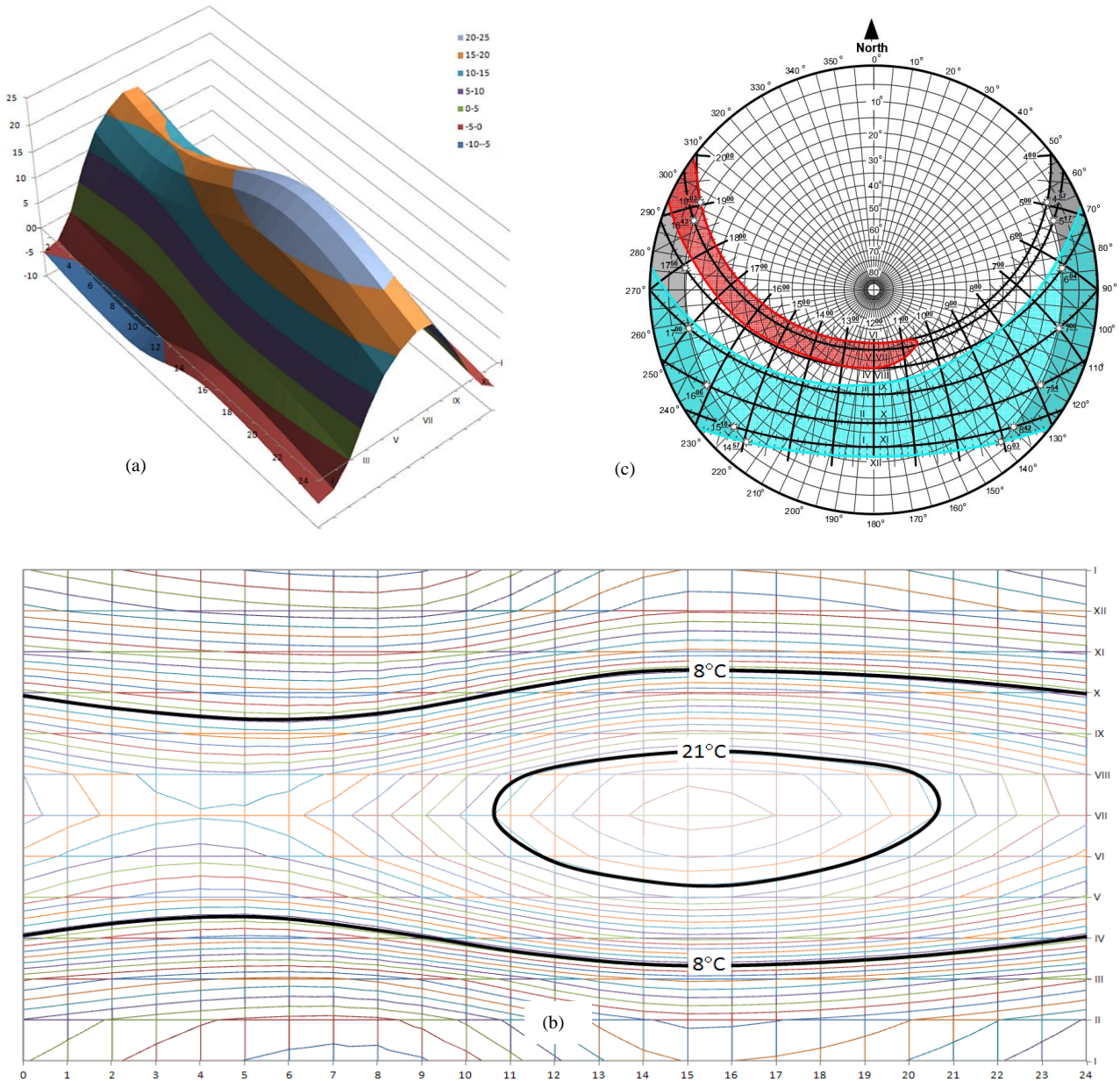

Figure 3. The plotting of complex solar map for Kiev, Ukraine
 (a) surface of temperatures, (b) isolines of temperatures, (c) complex solar map

■ - zone of unacceptable insolation; ■ - zone of acceptable insolation; ■ - zone that is not taken into account in insolation calculations

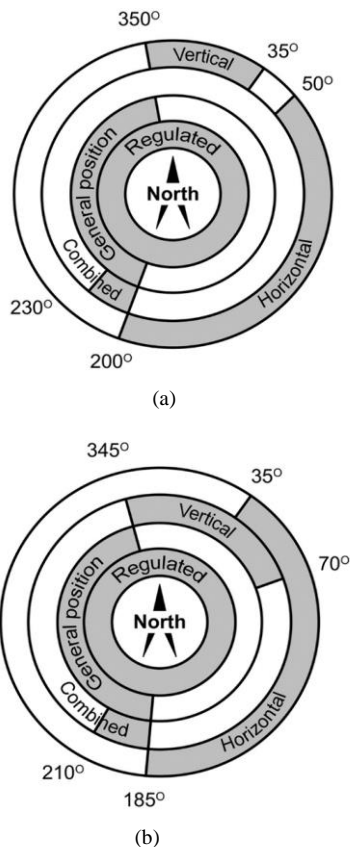

Figure 4. Diagrams for selecting the type of SSD depending on the orientation of the window: (a) for Kiev, (b) for Simferopol

The use of complex solar maps allows to take into account the peculiarities of the climate of the construction area when choosing a rational type of SSD, depending on the orientation of the facade to do this, knowing the configurations of shadow masks of different types of SSD [14], for the considered orientation of the facade, a type of SSD is selected, in which the zone of unwanted insolation is shaded, but, at the same time, the zone of desired insolation is minimally shaded. The orientation of the facade to do this, knowing the configurations of shadow masks of different types of SSD [14], for the considered orientation of the facade, a type of SSD is selected, in which the zone of unwanted insolation is shaded, but, at the same time, the zone of desired insolation is minimally shaded.

For example, in Figure 4 diagrams are constructed for choosing a rational type of SSD for Kiev and Simferopol. As you can see, they differ significantly from the generally accepted recommendations shown in Figure 2.

In [21] a comparison of the efficiency of the SSD for the southwestern facade of the reconstructed four-story building in Kiev with the superstructure of three more floors is considered (Figure 5). The built-on floors have solid glazing. In the initial version, an SSD with horizontal lamellas was designed on them, in the final version, inclined lamellae were used. This made it possible to completely shade the overheating zone with a practically completely open zone of the desired insolation. Geometry optimization of SSD for these floors gave almost 5% economy for heating of all building.

Complex maps are a good graphical tool for determining the geometric parameters of optimized SSD, but they do not allow quantifying their effectiveness. As is known, the external SSD is characterized by a decreasing shading coefficient $F_{sh,O}$, which is determined by the formula [22]:

$$F_{sh,O} = \frac{I_{sol,ps,mean}}{I_{sol,mean}} \quad (3)$$

where, $I_{sol,ps,mean}$ is average solar radiation actually hitting the receiving plane, shaded by an external object during the considered heating and cooling periods, respectively, W/m^2 ; $I_{sol,mean}$ is average solar radiation per receiving plane without shading, W/m^2 .

Optimized SSD has $F_{sh,O} \rightarrow 1$ in cooling period, $F_{sh,O} \rightarrow 0$, during the heating season. To quickly determine the effectiveness of designed solar shading devices, solar energy maps can be proposed. These maps are further enhancements to solar maps. They are obtained by drawing on a solar map for a plane of the corresponding orientation of 100 points, which are distributed over the map in accordance with the contribution of elementary sky areas to the irradiance of this plane Figure 6. Each point gives 1% of the irradiance of a plane of a given orientation from a completely open sky.

Currently, the solar energy maps were created for all architectural and building climatic regions of Ukraine in accordance with [16] for eight orientations of building facades. For this aim, representative cities were identified in each region:

- I district Kiev, Ukraine,
- II district Zaporozhye, Ukraine,
- III_a district Ivano-Frankivsk, Ukraine,
- III_b Uzhgorod, Ukraine,
- IV and V Simferopol, Ukraine.

The data of the solar radiation under real cloud cover were taken from [16]. The missing data were obtained by using the soft "Atmospheric Radiation" [23]. Maps were constructed separately for the heating period and the overheating period for vertical planes of eight orientations: N, NE, E, SE, S, SW, W, NW separately for direct and diffused solar radiation taking into account the real cloudiness of the sky.



(a)

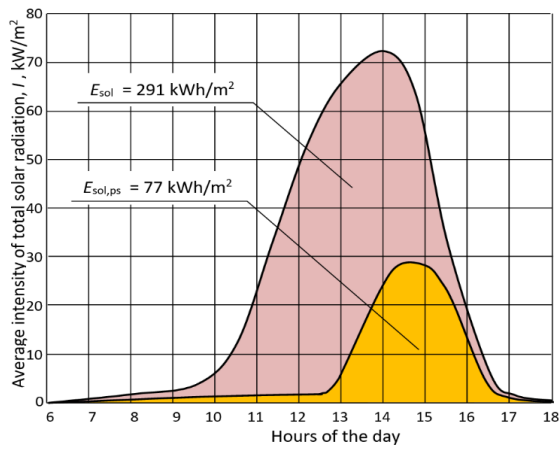

(b)

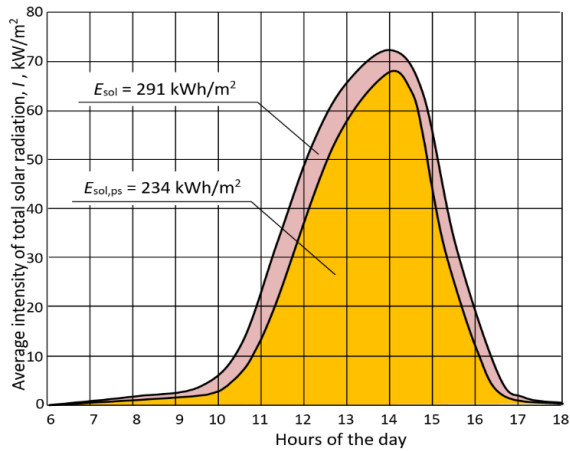

(c)

Figure 5. Receipt of total solar radiation during the heating period for glazing the facade of the reconstructed building in Kiev [21]: (a) general view of the building, (b) when using a horizontal SSD, (c) when using the optimized SSD

- with SSD
- without SSD

To determine heat gains on the solar energy map it is plotting a shadow mask of corresponding outdoor shading [15], Those points that are not closed by the shadow mask determine total percent of energy gain to the surface in considering shading. Such calculations are made separately for direct and diffused radiation. The reflected radiation from each individual object can be considered as uniformly bright, and the brightness can be defined as the product of the radiant illumination of this surface by its albedo. Figure 7 shows an example of designing the geometry of an optimized SSD.

At first, according to the diagram in Figure 4, the rational type of SSD is determined. In this case, it is a general-position SSD. Then an optimized outdoor shading shadow mask is constructed on a complex solar map. The contour of the shadow mask should touch the overheating zone Figure 7a Corresponding shadow goniometer Figure 8. have been developed for drawing shadow masks of SSD of general position to calculate angles of inclination of the guide lamellae 15, 30, 45 and 60° [24].

The resulting shadow mask applied to the solar energy map and the efficiency of the SSD is determined. In this case, the SSD completely blocks the sun's rays during the cooling period, and during the heating period it passes 97% of direct solar radiation Figure 7b.

Similarly, the percentage of its passing through the SSD during heating and cooling periods is determined by imposing a shadow mask on energy solar maps for diffused radiation.

Reducing shading coefficients for typical shading devices were calculated by using energy solar map [21] Figure 9. The coefficients take into account climatic features of various regions of Ukraine. This made it possible to compile the corresponding tables for the national application to GSU B EN ISO 13790 [25].

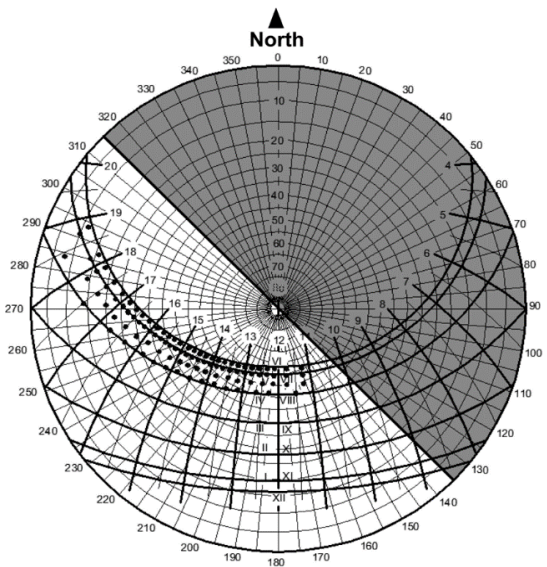
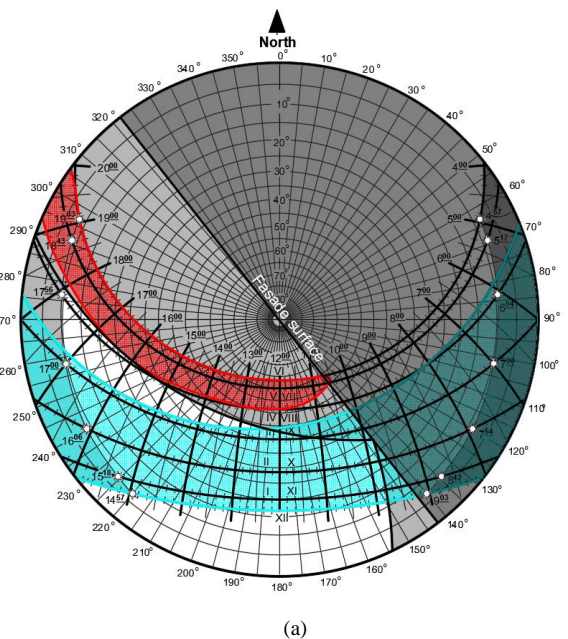

Figure 6. Energy solar map for a south-west facing facade in Kiev (direct radiation, overheating period)



(a)

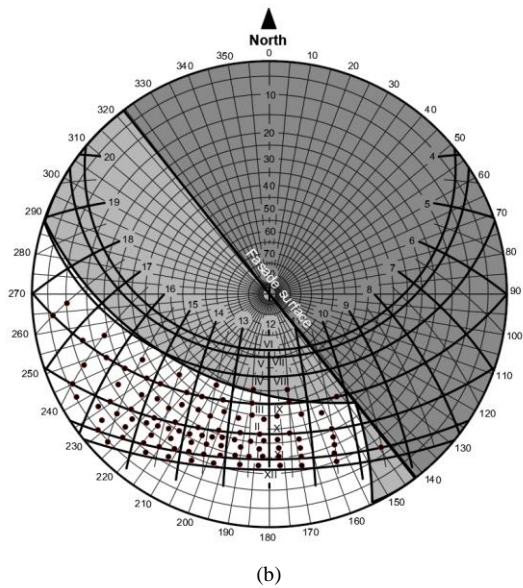

Figure 7. The example of designing an optimized SSD: (a) construction of shadow mask, (b) determination of efficiency for the heating season

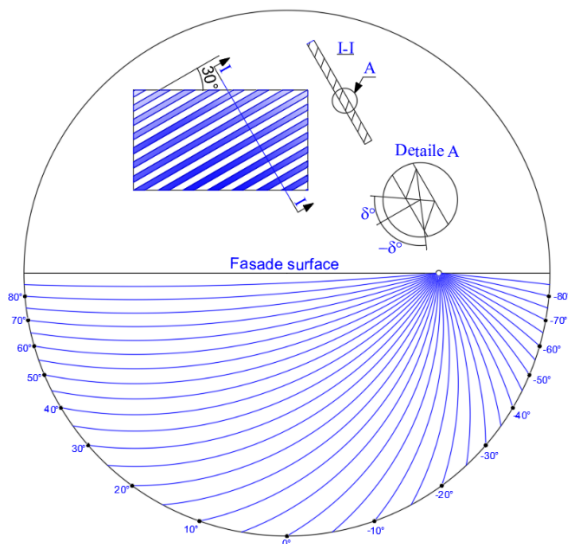

Figure 8. Shadow genimeters for calculating the SSD of general position of the western orientation [24]

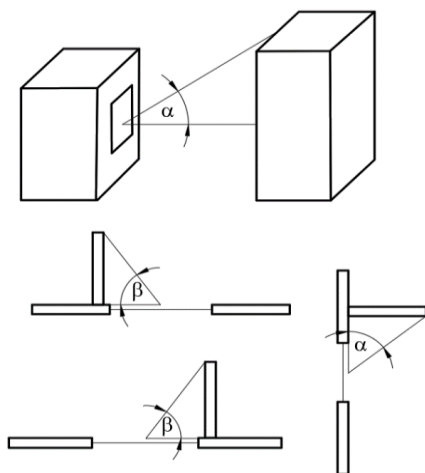

Figure 9. Types of shading considered in [22]

4. CONCLUSIONS

The complex and energy solar maps proposed in the article, methods of their construction and a design technique based on them for optimized sun-protection devices for buildings will significantly increase the efficiency of using sun-protection in energy-efficient construction. This toolkit and design methodology was developed for the implementation in Ukraine of regulatory requirements associated with the mandatory use of optimized sun protection to improve the energy efficiency of buildings. Directive 2018/844/EU of 30 May 2018, amending Directive 2010/31/EC on energy efficiency in buildings and Directive 2012/27/EC on energy efficiency, also emphasizes the need to maximize the application of the principles of passive use of solar energy in buildings, which is impossible without optimization of solar control.

In contrast to existing methods, the use of complex solar maps allows designers at the earliest design stage to choose a rational type of SSD, which takes into account the climatic features of the construction area and then calculate its geometric parameters at which solar radiation will not enter the building during the cooling period and maximally enter during the heating period. An important advantage of the proposed design methodology for the SSD is its visibility, in which the designer sees how the insolation regime of the premises changes throughout the year on one drawing. The designer will be able to assess the efficiency of the SSD using solar energy maps at the stage of energy certification of the building.

The development of integrated and energy solar maps for all regional centers of Ukraine and the creation of a national standard for the design of sun-protection devices is relevant. The method can be applied to develop similar solar maps in other countries.

REFERENCES

- [1] J. Bilbao, E. Bravo, O. Garcia, et al., "Establishing Performance Standards for Building of Almost Zero Consumption" International Journal on Technical and Physical Problems of Engineering (IJTPE), Issue 17, Vol. 5, No. 4, pp. 134-138, December 2013.
- [2] L. Bellia, C. Marino, F. Minichiello, A. Pedace, "An Overview on Solar Shading Systems for Buildings", Energy Procedia, Vol. 62, pp. 309-317, 2014.
- [3] P. Rajagopal, "Design of Shading Devices to Achieve Visual Comfort and Reduce Energy Consumption", A Literature Review, National Conference on Recent Trends in Architecture and Civil Engineering Towards Energy Efficient and Sustainable Development, Tiruchirappaiii, India, 2019, www.researchgate.net/publication/354209496.
- [4] A. Freewan, "Impact of External Shading Devices on Thermal and Daylighting Performance of Offices in Hot Climate Regions", Solar Energy, Vol. 102, pp. 14-30, 2014.
- [5] A. Freewan, "Developing Daylight Devices Matrix with Special Integration with Building Design Process", Sustainable Cities and Society, Vol. 15, pp. 144-152, 2015.
- [6] D.A. Chi, D. Moreno, M. Esquivias, J. Navarro, "Optimization Method for Perforated Solar Screen Design to Improve Daylighting using Orthogonal Arrays and

Climate-Based Daylight Modelling", *Jornal of Building Performance Simulation*, Vol. 10, pp. 144-160, 2017.

[7] A.T. Dvoretzky, M.A. Morgunova, O.V. Sergeichuk, A.B. Spiridonov, "Methods of Designing Immovable Sun Protection Devices", *Light & Engineering*, Vol. 25, No. 1, pp. 115-120, 2017.

[8] A.T. Dvoretzky, O.V. Sergeichuk, A.B. Spiridonov, "Application of Solar Maps in Design of General Position Shading Devices", *Light & Engineering*, Vol. 28, No. 6, pp. 105-109, 2020.

[9] EVS EN 17037 : 2019, "Daylight in Buildings", Estonian centre for standardization, EVS, p. 68, 2019.

[10] BS EN ISO 52022-1:2017, "Energy Performance of Buildings - Thermal, Solar and Daylight Properties of Building Components and Elements", Simplified Calculation Method of the Solar and Daylight Characteristics For Solar Protection Devices Combined with Glazing, 2017, www.thenbs.com/PublicationIndex/documents/details?Pub=BSI&DocID=319364.

[11] F. Haqparast, B.A. Maleki, "Simulation in the Building Design Process", *International Journal on Technical and Physical Problems of Engineering (IJTPE)*, Issue 20, Vol. 16, No. 3, pp. 109-115, September 2014.

[12] M. Vitruvius, "Ten Books on Architecture", Per. from Lat. F.A. Petrovsky, Editorial URSS, Moscow, p. 320, Russian, 2003.

[13] A. Steinberg, "Calculation of Insolation in Buildings", *Budivelnik*, Kiev, p. 120, 1975 (Russian).

[14] SP 370.1325800.2017, "Sun Protection Devices for Buildings", Design rules, *Standardinform*, p. 54, Moscow, 2018, <https://docs.cntd.ru/document/550965731>.

[15] DSTU-N B V.2.2-27:2010, "Nastanov on the Development of the Insolation of Civil Society", Ministry of Regional Development of Ukraine, *Ukrhhbudinform*, p. 81, Kiev, Ukraine, 2010.

[16] DSTU-N B V.1.1-27:2010, "Educational Climatology", Ministry of Education and Science of Ukraine, *Ukrhhbudinform*, p. 107, Kiev, Ukraine, 2011.

[17] SP 131.13330.2012. Updated version of SNiP 23-01-99, "Construction Climatology", Ministry of Construction of Russia, p. 120, Moscow, Russia, 2015.

[18] S. Joseph, Weisberg, *Meteorology: "The Earth and Its Weather"*, The 2nd edition, Houghton Mifflin, p. 427, New Jersey, 1981.

[19] L.T. Matveev, "General Meteorology Course, Physics of the Atmosphere", *Gidrometeoizdat*, p. 751, Leningrad, Russia, 1984.

[20] O. Sergeychuk, V. Shityuk, "Geometric Analysis of Climatic Indicators", *Pratsi Tavri. holding agrotechnological university*, Ad. 47, App. geom. and Eng. graph. Melitopol, Issue 4, TDATU, pp. 81-87, Ukraine, 2009.

[21] O. Sergeychuk, V. Buravchenko, V. Shityuk, "Features Account sun Shading Devices for Calculation of Energy Certification of Buildings", *Pratsi Tavri. Holding Agrotechnological University*, Ad. 47. App. geom. and eng., graph. Melitopol, Issue 4, TDATU, pp. 44-50, Ukrain, 2009.

[22] DSTU B A 2.2-12 2015, "Method of Developing Energy Supply for Scorching, Cooling, Ventilation,

Illumination and Hot Water Supply", *Minregion of Ukraine, Ukrhhbudinform*, p. 158, Ukraine, 2016.

[23] V. Bazhenov, P. Lizunov, O. Sergeychuk, et al., "Applied Software, Atmospheric Radiation for an Energy Efficient Building", *The 14th Intern. Conf. on Computing in Civil and Building Engineering (ICCCBE)*, p.8, 2012, www.icccbe.ru/paper_long/0327paper_long.pdf.

[24] O. Sergeychuk, V. Buravchenko, "Solar Shading Device of Buildings: Guidelines for Performing Work in the Discipline", *Special Engineering and Design Solutions for Foreign Students of Specialties*, 7.120101, "Architecture of Buildings and Structures", 7.120102, "Urban Planning", 7.120103, "Design of the Architectural Environment", KNUBA, Russia, 2015.

[25] O. Sergeychuk, V. Buravchenko, O. Andropova, "Features of the Methodology for Calculating Solar Revenues in the National Annex to DSTU B EN ISO 13790", *Energy Efficiency in Construction and Architecture*, KNUBA, Issue 6, pp. 267-272, Russia, 2014.

BIOGRAPHIES



Oleg V. Sergeychuk was born in Ovruch, Ukraine in 1953. In 1976 he graduated from Architectural Faculty, Kiev Technical University of Construction and Architecture, Kiev, Ukraine. In 1979 he received the Ph.D. degree in Applied Geometry from Kiev Technical

University of Construction and Architecture. In 2009 he received the Full Doctor of Technical Sciences degree in Applied Geometry from Kiev National University of Construction and Architecture. Since 1979 he has been working at Department of Architectural Constructions, Kiev National University of Construction and Architecture, Kiev, Ukraine. Currently, he is a Full Doctor of Technical Sciences, Full Professor at Department of Architectural Constructions, Kiev National University of Construction and Architecture. His research interests include the building physics, energy efficient buildings, solar energy. Participates in the creation of building codes for energy efficiency.



Olga V. Andropova was born in Kiev, Ukraine in 1983. In 2006 she graduated from Architectural Faculty, Kiev National University of Construction and Architecture, Kiev, Ukraine. In 2021 she received the Ph.D. degree in Applied Geometry and Engendering

Graphics from Kiev National University of Construction and Architecture. Since 2007 she has been working at Department of Architectural Constructions, Kiev National University of Construction and Architecture. She is a Candidate of Science (Ph.D.), Associate Professor of Department of Architectural Constructions of Kiev National University of Construction and Architecture. Her research interests include architecture construction, energy efficient buildings, solar energy, applied geometry.



Yurii V. Kozak was born in Kiev, Ukraine in 1973. In 1995 he graduated from Building Faculty, Kiev Technical University of Construction and Architecture, Kiev, Ukraine. In 2021 he received the Ph.D. degree in Applied Geometry and Engendering

Graphics at Kiev National University of Construction and Architecture. Since 1999 he has been working at Department of Architectural Constructions of Kiev National University of Construction and Architecture. He is a Candidate of Science (PhD), Associate Professor of Department of Architectural Constructions, Kiev National University of Construction and Architecture. His research interests include the methods of synthetic geometry, object-oriented methods in applied geometry, architecture construction, energy efficient buildings, acoustics.



Elena N. Scherbakova was born in Kiev, Ukraine in 1962. In 1986 she graduated from Law Faculty of Taras Shevchenko National University, Kiev, Ukraine. Since 1985 she has been working at Department of Architectural Constructions, Kiev

National University of Construction and Architecture, Kiev, Ukraine. She is the senior lecturer of Department of Labour Protection and Environment, Kiev National University of Construction and Architecture, Kiev, Ukraine. Her research interests include the environmental law, intellectual property.