

## IMPROVED A SENSORLESS INPUT-OUTPUT LINEARIZATION CONTROL OF PERMANENT MAGNET SYNCHRONOUS MOTOR USING PARTICLE SWARM OPTIMIZATION

A. Essalmi<sup>1</sup> H. Mahmoudi<sup>2</sup> A. El Janati El Idrissi<sup>3</sup>

1. Department of Physics, School of Normal Superior, Mohammed V University, Rabat, Morocco  
adessalmi@gmail.com

2. Electronics Power and Control Team, Mohammadia School of Engineers, Mohammed V University, Rabat, Morocco  
mahmoudi@emi.ac.ma

3. LTI Laboratory, ENSAT, Abdelmalek Essaadi University, Tetouan, Morocco, ajanatiidrissi@uae.ac.ma

**Abstract-** This paper presents a study of an intelligent Sensorless Control of Permanent Magnet Synchronous Motors (PMSM). In order to solve the problems due to using the position sensor of the PMSM in traditional control, such as the high cost, large volume, low reliability and susceptibility to environment disturbance and so on, a estimation method of motor Speed and rotor position based on Luenberger Observer (LO) with a stochastic optimization technique using a Particle Swarm Optimization (PSO) algorithm to find the best values of Matrix gains of this observer. Firstly, a discrete mathematical model of PMSM in d-q coordinates system is established, then the model of Sensorless Input-Output Linearization Control (IOLC) system with the controller is built by using A proportional-integral (PI) controller optimized by PSO (PI-PSO), next we insert the PSO-LO in IOLC block of PMSM. Finally, the simulation results show that the proposed control is capable of tracking the actual values of motor position, rotation Speed, and resistant Torque, with high estimation accuracy, steady running and good robustness.

**Keywords:** Permanent Magnet Synchronous Motor (PMSM), Input-Output Linearization (IOL), Particle Swarm Optimization (PSO), Luenberger Observer (LO).

### 1. INTRODUCTION

PMSM are generally used for high dynamic and performance motor drives. Due to advances in power and digital electronics a lot of research work has been developed at various approaches to control torque, Speed and flux, of electrical machines at real time. Nowadays, PI (Proportional-Integral) controller is one of the most frequently used controller structures in control loops due to many advantages. But tuning of PI controller is a challenging exercise. The paper [1] present a study of tuning the PID controller by Genetic Algorithm and PSO, the proposed technique is compared with conventionally PID based on Ziegler-Nichols, those techniques used for control a DC motor and an automatic regulator voltage.

The results of simulation show the good performance (overshoots, rise time and settling time) of proposed technique than the conventionally tuned PID controllers. [2] Used Grey wolf optimizer (GWO) for tuning a PID controller, the simulation result shows the efficiency and the advantage of the GWO algorithm compared to that of PSO in terms of temporal characteristics such as response time. [3] Proposed to using a controller PID tuned by Genetic Algorithm, to controlling Stirred Tank Reactor. The result of simulation shows a good performance of this technique compared to fixed PID parameters. In [4] the purpose of the study is an online setting PID fuzzy controller based on Extended Kalman Filter to achieve the best performance control with high stability.

In this paper, instead of using the traditional technique for tuning PI controller we as a novel technique based on PSO algorithm for control of PMSM.

For controlling of electrical machine, we need always the information given by an encoder or a resolver sensor to determine the position and/or rotation Speed of electrical machines, this mechanical sensor given various drawbacks due to the additional cost, additional electronic circuit for processing information and more cables. Because of that, at last, twenty years, many researches have been developing with the aim of controlling of electrical machine without a mechanical sensor. For example, the [6] present a sensorless control of PMSM based on extended Kalman filter estimation, the simulation results are presented and are verified the feasibility and validity on the proposed technique, with a good performance of the Speed response. The [7] is a study of sensorless field-oriented control of PMSM based on sliding mode observer, the experimental results indicate the robustness of sliding mode observer to parametric variations. The [8] studies of a simple estimator of rotor position and Speed of permanent magnetic synchronous motor based on adaptive controller.

The [9] presents a sensorless control of Motor Control Brushless DC using improved sliding mode observer technique.

In this paper we give a study of a sensorless IOLC of PMSM controlled by PI - PSO controller and the estimate electromagnetic torque is done by an estimator based on a Luenberger Observer (LO) tuned by PSO algorithm instead of using the classical method. The PSO algorithm uses a fitness function designed to reduce the overshoot and response time.

The proposed control is detailed in Figure 1, and organized as follows: In section 2, Dynamic model of PMSM is developed, the objective of IOLC is presented in section 3, the PSO technique in section 4, the LO used in the control in sections 5, simulation results and parameters of the motor are given in section 6. Section 7 presents the conclusion.

**2. EQUATIONS OF DYNAMIC MODEL OF PMSM**

The electrical equations of the PMSM in (d-q) reference is given by [10]:

$$U_d = Ri_d - \omega_r \phi_q + \frac{d\phi_d}{dt} \tag{1}$$

$$U_q = Ri_q - \omega_r \phi_d + \frac{d\phi_q}{dt} \tag{2}$$

$$\phi_d = L_d i_d + \phi_m \tag{3}$$

$$\phi_q = L_q i_q \tag{4}$$

The electromagnetic torque  $T_e$  is:

$$T_e = \frac{3}{2}(\phi_m i_q + (L_d - L_q) i_d i_q) \tag{5}$$

The motor dynamics equations is:

$$\frac{d\omega_r}{dt} = \frac{p}{J}(T_e - f_c \omega_r - T_r) \tag{6}$$

Where,

$U_d$  : Direct-axis stator voltage;

$U_q$  : Quadrature-axis stator voltage;

$i_d$  : Direct-axis stator current;

$i_q$  : Quadrature-axis stator current;

$L_d$  : Direct-axis stator inductance;

$L_q$  : Quadrature-axis stator inductance;

$\phi_d$  : Direct-axis stator flux;

$\phi_q$  : Quadrature-axis stator flux;

$p$  : Number of poles;

$R$  : Stator resistance;

$\phi_m$  : Rotor magnet flux linkage;

$\omega_r$  : Mechanical rotor Speed;

$f_c$  : Coefficient of viscous friction;

$T_r$  : Resistive torque;

The concept of input-output linearization is well known. Several studies describe this technique [11], [12]. The system of PMSM is exactly linearizable because the order of the PMSM system equal to the relative degree of system [10].

The relation input-output of the model is given by (Equations (7) to (11)) [10]:

$$[\dot{y}_1 \quad \dot{y}_2]^T = \xi(x) + D(x)[u_d \quad u_q]^T \tag{7}$$

where,

$$\xi(x) = \begin{bmatrix} -\frac{R}{L_d} i_d + \frac{L_q}{L_d} p \omega_r i_q \\ \Lambda(L_d - L_q) i_q f_1(x) + \Lambda(\phi_v + (L_d - L_q) i_d) f_2(x) - \frac{f}{J} f_3(x) \end{bmatrix}^T \tag{8}$$

and

$$D(x) = \begin{bmatrix} \frac{1}{L_d} & 0 \\ \frac{\Lambda(L_d - L_q)}{L_d} i_q & \frac{\Lambda(\phi_v + (L_d - L_q) i_d)}{L_q} \end{bmatrix} \tag{9}$$

$$f(x) = \begin{bmatrix} \frac{1}{J}(-Ri_d + pL_q \omega_r i_q) \\ \frac{1}{J}(-Ri_q + pL_d \omega_r i_d - p\phi_v \omega_r) \\ \frac{1}{J}(\frac{3p}{2}(\phi_v i_q + (L_d - L_q) i_d i_q) - T_r - f \omega_r) \end{bmatrix} \tag{10}$$

$$y_1 = i_d, y_2 = \omega_r \text{ and } \Lambda = \frac{3p}{2J}$$

The structure of linearization closed-loop system is illustrated in Figure 2.

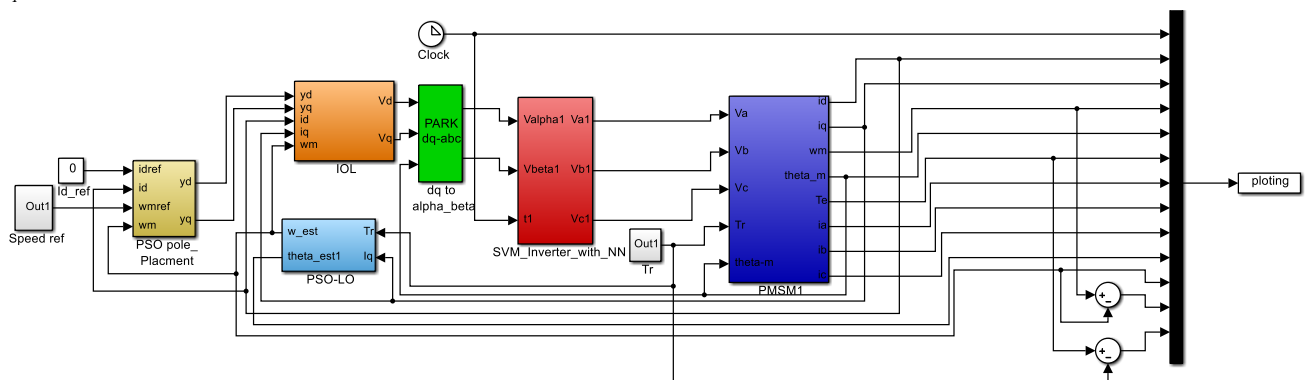

Figure 1. Simulation Scheme of sensorless PSO-IOL of a PMSM

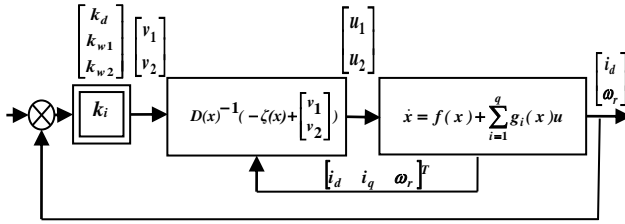

Figure 2. The Block of closed-loop linearization system [10]

The NL input-output control is defined by a relation (Equation (11)) who connects the new internal inputs  $v_1$  and  $v_2$  with physical inputs  $u_d$  and  $u_q$  as follow:

$$\begin{bmatrix} u_d \\ u_q \end{bmatrix} = D(x)^{-1} \begin{bmatrix} v_1 \\ v_2 \end{bmatrix} - \zeta(x) \quad (11)$$

To impose the static mode and a dynamic on the error, the internal inputs are calculated by Equation (12) [10].

$$\begin{bmatrix} v_1 \\ v_2 \end{bmatrix} = \begin{bmatrix} k_d(i_{dref} - i_d) \\ \ddot{\omega}_{ref} + k_{\omega 1}(\dot{\omega}_{ref} - \dot{\omega}_r) + k_{\omega 2}(\omega_{ref} - \omega_r) \end{bmatrix} \quad (12)$$

But if the imposed trajectory is a level (constant), then  $\dot{\omega}_{ref} = \ddot{\omega}_{ref} = 0$  and the Equation (12) becomes:

$$\begin{bmatrix} v_1 \\ v_2 \end{bmatrix} = \begin{bmatrix} k_d(i_{dref} - i_d) \\ \ddot{\omega}_{ref} + k_{\omega 1}\dot{\omega}_r + k_{\omega 2}(\omega_{ref} - \omega_r) \end{bmatrix} \quad (13)$$

In closed loop, the tracking error is:

$$\begin{cases} e_{id} = i_{dref} - i_d \\ e_{\omega} = \omega_{dref} - \omega_r \end{cases} \quad (14)$$

where,  $e_{\omega}$ ,  $e_{id}$ , are the errors of reference trajectories. By passing in the plan of Laplace, the system (Equation (13)) becomes:

$$\begin{cases} s + k_d = 0 \\ s^2 + k_{\omega 2}.s + k_{\omega 1} = 0 \end{cases} \quad (15)$$

Finally, we find the values of  $k_d$ ,  $k_{\omega 1}$  and  $k_{\omega 2}$ , by resolving the system (Equation (15)). But we not find exact values, because this method is based on mathematical equation. However, we use PSO technique to optimize  $k_d$ ,  $k_{\omega 1}$  and  $k_{\omega 2}$ .

### 3. PSO ALGORITHM

PSO is an optimization algorithm based on evolutionary computation technique. The basic PSO is developed from research on swarm such as fish schooling and bird flocking. PSO was firstly introduced in 1995 [13]. To improve the performance of the original PSO a modified PSO was then introduced in 1998 [14].

The updated of particles is according to the Equation (16) [13]:

$$\begin{aligned} v_{ij}(k+1) &= wv_{ij}(k) + c_1r_1(p_{ij}(k) - x_{ij}(k)) + c_2r_2(g_i(k) - x_{ij}(k)) \\ x_{ij}(k+1) &= x_{ij}(k) + v_{ij}(k+1) \end{aligned} \quad (16)$$

where,

- $i = 1, 2, \dots, d$  with  $d$  dimension of particles.
- $x_{ij} = (x_{i1}, x_{i2}, \dots, x_{id})$  is the  $i$ th particle.

The [15] showed that the performances are similar in the case of a swarm sizes 10 to 50. In this paper we set 40

a size of used swarm.

- $p_{best}$ : best previous position represented as  $p_{ij} = (p_{i1}, p_{i2}, \dots, p_{id})$ .
- $g_{best}$ : Best particle in all the population.
- $v_{ij} = (v_{i1}, v_{i2}, \dots, v_{id})$ : The velocity of particle  $i$ .
- $c_1$  and  $c_2$  are adjustable cognitive acceleration constant.
- $r_{1,2}$  is constant between 0 and 1,
- $k$  iteration.
- $w$ : Inertia weight and  $w = 0.729$  is a proposed value by Clerc [16] guaranteed the convergence of PSO.

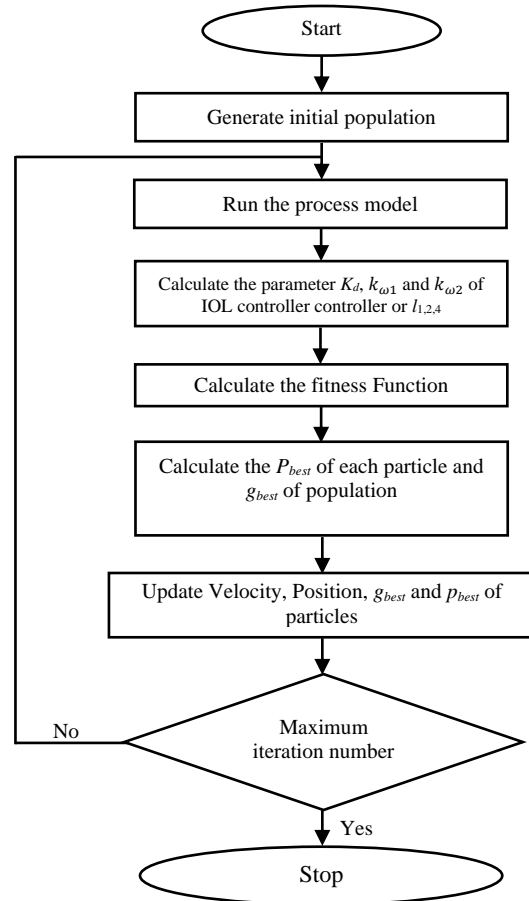

Figure 3. Flowchart of steps of PSO

The performance of each particle is measured by using a fitness function. In this paper, we considered two parameters based objective function by considering the ITAE and IAE, mathematically expressed as:

$$f(k_{d,\omega_1,\omega_2}, l_{1,2,3}) = w_1.ISE + w_2.IAE \quad (15)$$

- IAE: Integrated-Absolute-Error.

- ISE: Integral-Square-Error.

The weighting function  $w_1 = w_2 = 0.5$ .

The steps of PSO are illustrated in Figure 3.

### 4. OBSERVER OF LUENBERGER

A state observer is represented in Figure 4 [18], [19]. The state observer structure is completed by a matrix of Gain ( $L$ ) in the feedback chain for error correction between the estimated value and the system output.

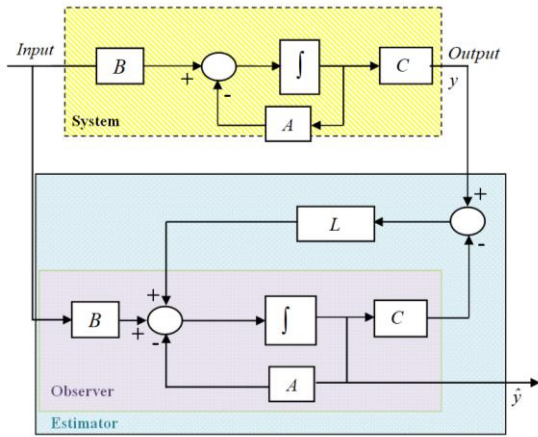

Figure 4. The structure of an observer of state associated with the system [17]

A good choice of the matrix gains ( $L$ ) increases the performance of observer (increase the dynamics of observer, and decrease the estimation error). In this paper, the PSO algorithm is used to optimize the value of the matrix gain ( $L$ ). Nonlinear state equations of PMSM used in LO are given by [18]:

$$\dot{x} = A.x + B.u \tag{18}$$

$$y = C.x$$

where,

$$u = i_q$$

$$x = [\theta \quad \omega \quad T_r]^T \tag{19}$$

$$\begin{bmatrix} 0 & 1 & 0 \\ 0 & -\frac{f_c}{J} & -\frac{1}{J} \\ 0 & 0 & 0 \end{bmatrix} \tag{20}$$

$$B = \begin{bmatrix} 0 & \frac{p\lambda_m}{J} & 0 \end{bmatrix}^T \tag{21}$$

The state equation of LO is given by:

$$\frac{d\hat{x}}{dt} = A\hat{x} + Bu + L(x - \hat{x}) \tag{22}$$

$$L = \begin{bmatrix} 0 & 0 & 0 \\ l_2 & l_1 & 0 \\ l_3 & 0 & 0 \end{bmatrix} \tag{23}$$

The observer state can be described by Equation (24):

$$\frac{d\hat{\theta}_r}{dt} = \hat{\omega}_r \tag{24}$$

$$\frac{d\hat{\omega}_r}{dt} = \frac{1}{J}(T_e - \hat{T}_e) - \frac{f_c}{J}\hat{\omega}_r + l_1(\omega_r - \hat{\omega}_r) + l_2(\theta_r - \hat{\theta}_r)$$

$$\frac{d\hat{T}_r}{dt} = l_2(\theta_r - \hat{\theta}_r) \tag{25}$$

The structure of PSO- Observer Luenberger associated with PMSM is shown in Figure 5. In matrix gain of Equation (23), the variables  $l_1$ ,  $l_2$  and  $l_3$  are determined by PSO algorithm.

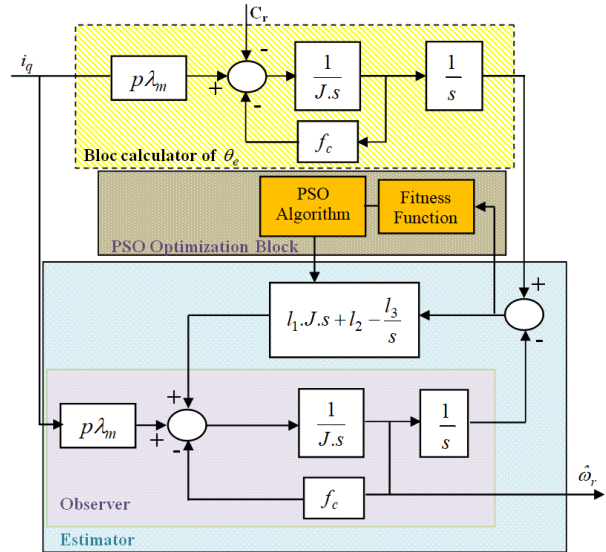

Figure 5. Structure of PSO-OL of state in association with PMSM

### 5. PARAMETERS OF PMSM, PSO AND SIMULATION RESULT

The parameters of PMSM are shown in Table 1. The parameters of PSO are shown in Table 2. The simulation results are also shown in Figure 6.

Table 1. Parameters of PMSM [10], [17]

Parameter	Value	Unit
stator resistance	1.4	$\Omega$
d-axis inductance	6.6	mH
q-axis inductance	5.8	mH
magnetic flux constant	0.1546	Wb
Friction coefficient	0.00038	$N.m.rad.s^{-1}$
Motor inertia	0.00176	$Kg.m^2$

Table 2. Parameter of PSO

Variable	Value	Description
$i$	40	Size of the swarm
$k$	100	Iteration number
$c_1$	1.8	cognitive acceleration constant
$c_2$	1.2	cognitive acceleration constant
$w$	0.729	Inertia weight
$r_{1,2}$	0.8	random function
$l_1$	183	variables of Matrix gain of Luenberger Observer
$l_2$	147	
$l_3$	0.7	
$k_d$	274	Parameters of PI controller used in IOL control
$k_{\omega 1}$	113	
$k_{\omega 2}$	73	

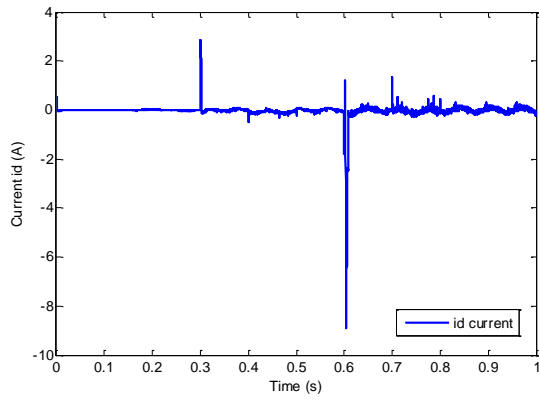

Figure 6-a. Current direct component

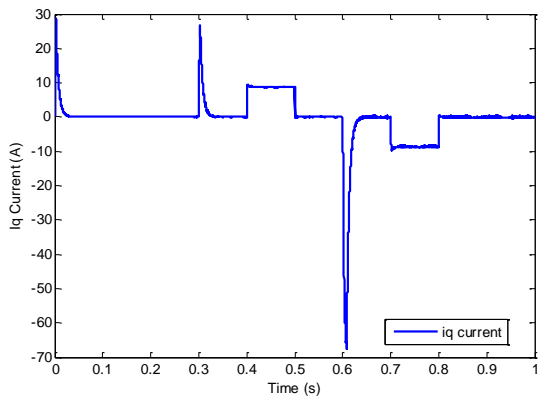

Figure 6-b. Current quadrature component

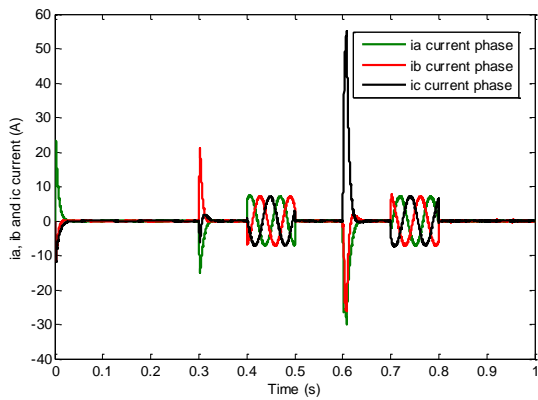

Figure 6-c. Three phase currents

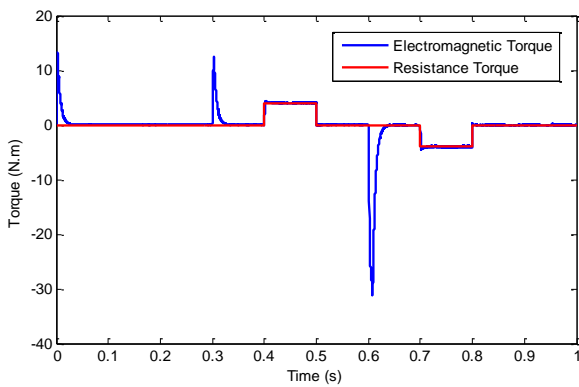

Figure 6-d. Resistance and electromagnetic torque

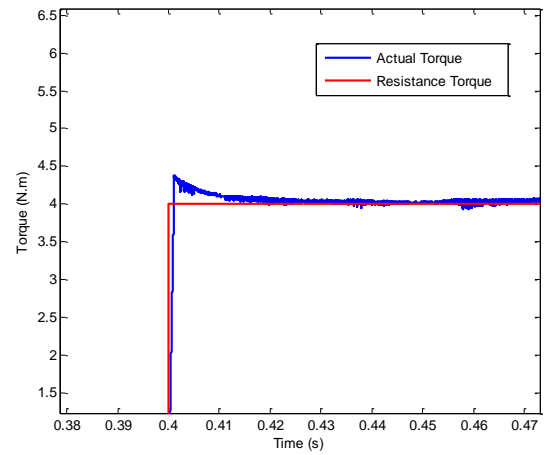

Figure 6-e. Zoom in torque response

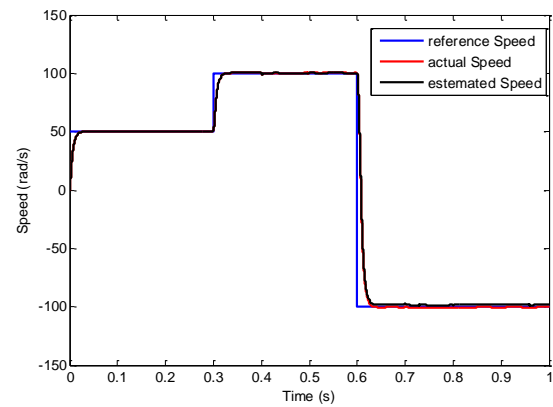

Figure 6-f. Rotation speed

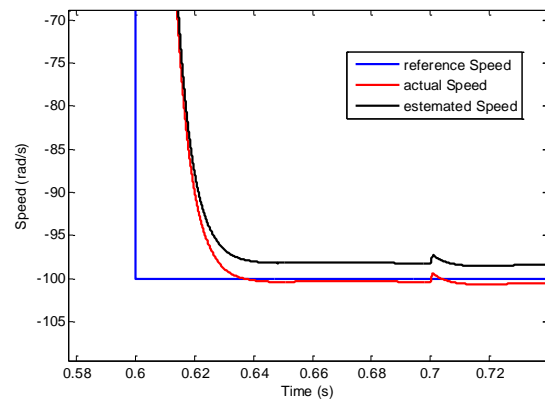

Figure 6-g. Zoom in speed response

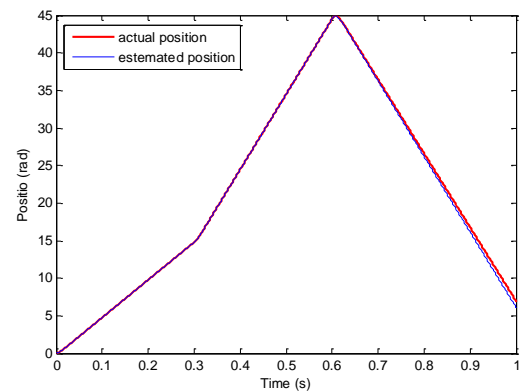

Figure 6-h. Rotor position

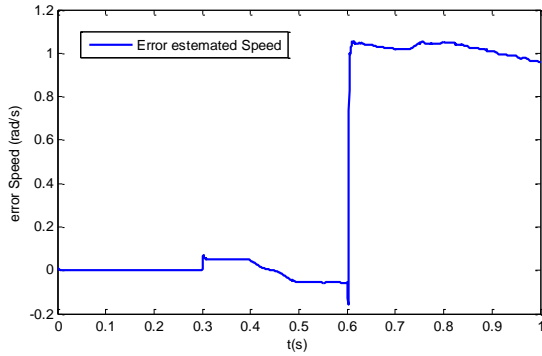

Figure 6-i. Error estimated speed

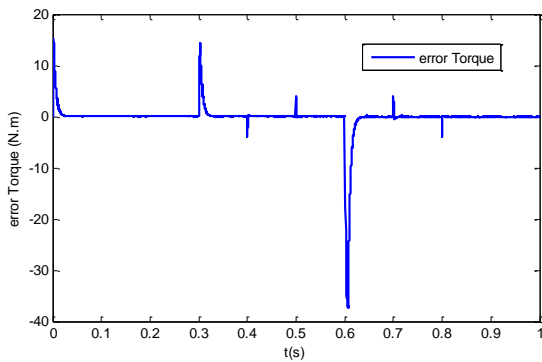

Figure 6-j. Error control torque

Figure 6 shows simulation results ( $i_d$ ,  $i_q$ ,  $i_a$ ,  $i_b$ ,  $i_c$ , torque, speed, position theta, error speed and error torque) without variation parameter system.

To illustrate the performances of the proposed control we applied the reference below:

- Speed references:

$$\begin{cases} \omega_{ref} = 50 \text{ rad.s}^{-1} & \text{at } t < 0.2 \text{ s} \\ \omega_{ref} = 100 \text{ rad.s}^{-1} & \text{at } 0.2 \text{ s} < t < 0.6 \text{ s} \\ \omega_{ref} = 100 \text{ rad.s}^{-1} & \text{at } 0.6 \text{ s} < t < 1 \text{ s} \end{cases}$$

- Load references:

$$\begin{cases} C_r = 4 \text{ N.m} & \text{at } 0.4 \text{ s} < t < 0.45 \text{ s} \\ C_r = 4 \text{ N.m} & \text{at } 0.65 \text{ s} < t < 0.8 \text{ s} \\ C_r = 4 \text{ N.m} & \text{at other times} \end{cases}$$

According to Figure 6, we notice that:

- The Speed and torque response achieved the references quickly with rejection of harmonic ripples in comparison with [10] (Figures 6-d and 6-f).
- The current  $i_s$  remains null ( $i_d = 0$ ) and current  $i_q$  is limited to a maximum acceptable value (Figures 6-a and 6-b).
- The static error of control of Torque is negligible (Figures 6-d and 6-j).

The estimated speed is approximately equal to the current Speed (Figures 6-f and 6-g), with an error negligible (equal to 1% of reference speed)

The phase currents  $i_a$ ,  $i_b$  and  $i_c$  its sinusoidal with less harmonics.

To test the robustness of proposed control, we studied the influence of variation of stator resistances and inertia of the motor by a value of  $+50\%R_s$  and  $+50\%J$ . With applied the reference speed  $\omega_{ref} = 100 \text{ rad/s}$  and a load  $C_r = 4 \text{ N.m}$  at  $t = 0.2 \text{ s}$ .

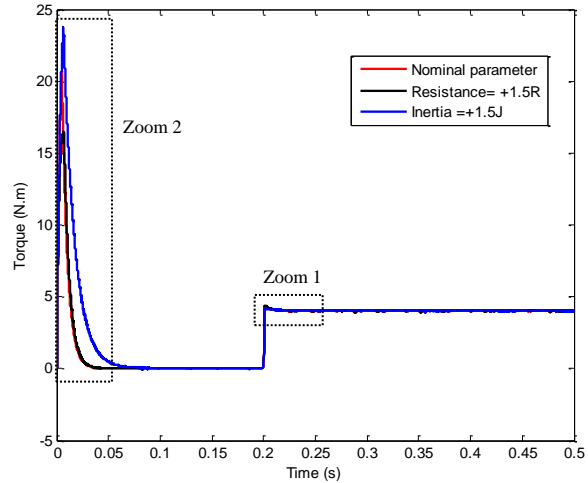

Figure 7-a. Electromagnetic torque with variation of parameters

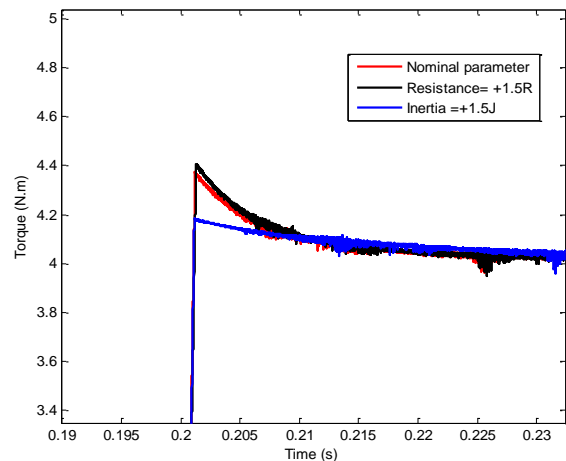

Figure 7-b. Zoom 1 in torque response

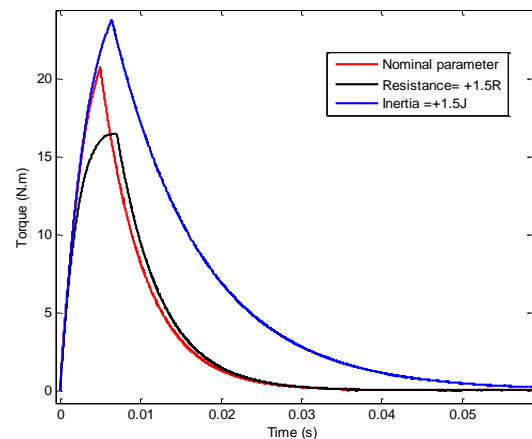

Figure 7-c. Zoom 2 in torque response

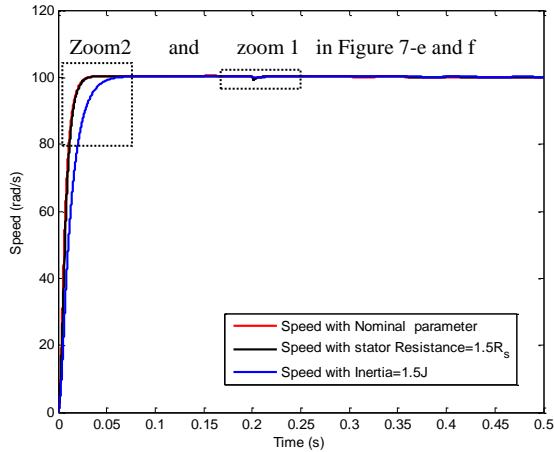

Figure 7-d. Rotation speed with variation parameters

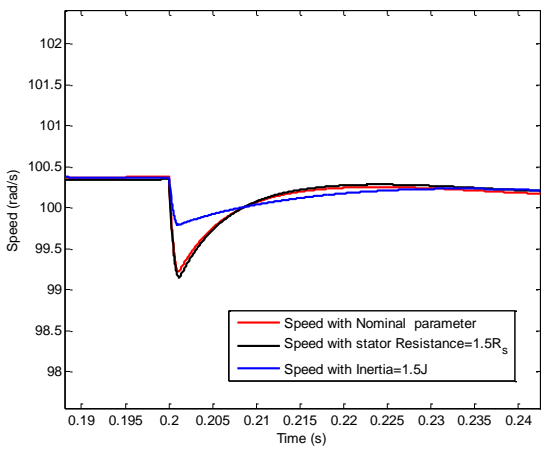

Figure 7-e. Zoom 1 in speed response

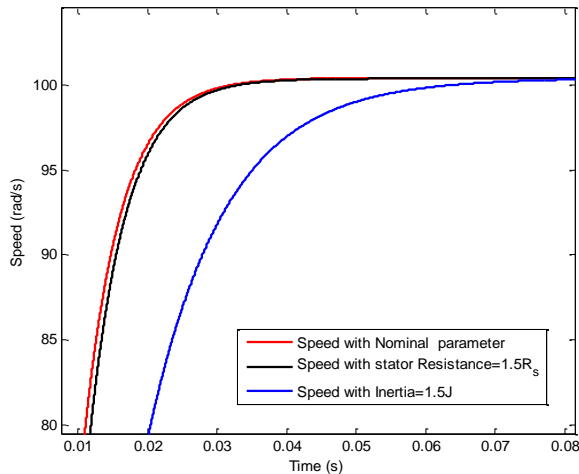

Figure 7-f. Zoom 2 in speed response

Figure 7 shows Simulation results (torque and speed) with variation parameters of system. The result of simulation (Figure 7) shows that, the proposed control is adaptive and robust to the variation of parameter of motor (stator resistance and inertia of motor). The Speed follows quickly its reference with a negligible effect on the response time in case of a variation of inertia value ( $T_r = 0.02$  s to  $T_r = 0.04$  s), but the system remains stable during the application of the load.

In general, the results of simulation show the good performances and robustness of the PSO-IOL control of a PMSM using PSO-Luenberger Observer estimator, described in this paper.

### 6. CONCLUSION

In this paper, we have studied the sensorless Input output linearization control of permanent magnetic synchronous Motor based on particle swarm optimization algorithm to tuning the PI controller and matrix gain of Luenberger Observer.

The results of simulations show that the effectiveness of proposed control and the used PSO algorithm for tuning the parameters of PI controller and matrix gain of the observer. The error between the reference Speed and current Speed, between the reference torque, motor torque and estimated torque converges to zero with better dynamic performance and good robustness.

### REFERENCES

- [1] A. Salem, M.A. Moustafa Hassan, M.E. Ammar "Tuning PID Controllers Using Artificial Intelligence Techniques Applied To DC-Motor and AVR System" Asian Journal of Engineering and Technology Vol. 02, No. 02, pp. 129-138, April 2014.
- [2] F. Loucif, S. Kechida, A. Sebbagh, "Heuristic Methods for Optimization of a PID Controller for the Control of a Robot Manipulator", The 3rd International Conference on Electromechanical Engineering (ICEE), pp. 21-22, Skikda, Algeria, November 2018.
- [3] A. Jayachitra1, R. Vinodha, "Genetic Algorithm Based PID Controller Tuning Approach for Continuous Stirred Tank Reactor", Hindawi Publishing Corporation Advances in Artificial Intelligence, Article ID 791230, 2014.
- [4] Sh. Javadi, N.M. Tabatabaei, S.R. Mortezaei, "Robust Extended Kalman Filter in Online Tuning Fuzzy PID Controller for Nonlinear Path Following One Unmanned Ground Vehicles", International Journal on Technical and Physical Problems of Engineering (IJTPE), Issue 34, Vol. 10, No. 1, pp. 6-15, March 2018.
- [5] P. Gwangmin, G. Kim, B.G. Gu, "Sensorless PMSM Drive Inductance Estimation Based on a Data-Driven Approach", Electronics, Vol. 10, No. 7, Issue 791, 2021.
- [6] Y. Zhang, X.F. Cheng, "Sensorless Control of Permanent Magnet Synchronous Motors and EKF Parameter Tuning Research", Mathematical Problems in Engineering, Article ID 3916231, 2016.
- [7] O. Saadaoui, A. Khlaief, M. Abassi, A. Chari, M. Boussak, "Sensorless FOC of PMSM Drives Based on Full Order SMO", The 17th International Conference on Sciences and Techniques of Automatic Control and Computer Engineering (STA), pp. 663-668, 2016.
- [8] J. Mat Lazi, Z. Ibrahim, M. Talib, A. Alias, A. Nur, M. Azri, "Speed and Position Estimator of for Sensorless PMSM Drives Using Adaptive Controller", International Journal of Power Electronics and Drive System (IJPEDS) Vol. 10, No. 1, pp. 128-136, March 2019.
- [9] M. Topal, I. Iskender, N. Genc, "Sensorless Speed Control of a BLDC Motor Using Improved Sliding Mode

Observer Technique", International Journal on Technical and Physical Problems of Engineering (IJTPE), Vol. 11, Issue 38, No. 1, pp. 1-9, March 2019.

[10] A. Essalmi, H. Mahmoudi, "Neuro Genetic Input-Output Linearization Control of PMSM", Journal of Theoretical and Applied Information Technology, Vol. 37, pp. 105-111, 2012.

[11] M.R. Marino, S. Peresada, P. Valigi, "Adaptive Input-Output Linearizing Control of Induction Motors", IEEE Transactions on Automatic Control, Vol. 38, No. 2, pp. 208-221, Feb. 1993.

[12] A. Massoum, M.K. Fellah, A. Meroufel, A. Bendaoud, "Input Output Linearization and Sliding Mode Control of a Permanent Magnet Synchronous Machine Fed by A Three Levels inverter", Journal of Electrical Engineering, Vol. 57, No. 4, pp. 205-210, 2006.

[13] J. Kennedy, R. Eberhart, "Particle Swarm Optimization", International Conference on Neural Networks (ICNN'95), Vol. 4, pp. 1942-1948, 1995.

[14] Y. Shi, R. Eberhart, "A Modified Particle Swarm Optimizer", IEEE International Conference on Evolutionary Computation Proceedings, IEEE World Congress on Computational Intelligence, pp. 69-73, 1998.

[15] R.C. Eberhart, Y. Shi, "Comparing Inertia Weights and Constriction Factors in Particle Swarm Optimization", Congress on Evolutionary Computation (CEC00), Vol. 1, pp. 84-88, 2000.

[16] M.M. Clerc, "The Swarm and the Queen: Towards a Deterministic and Adaptive Particle Swarm Optimization", Congress on Evolutionary Computation (CEC99), Vol. 3, pp. 1951-1957, 1999.

[17] H. Mahmoudi, A. Essalmi, "Neuro-Genetic Sensorless Sliding Mode Control of a Permanent Magnet Synchronous Motor Using Luenberger Observer", Journal of Theoretical and Applied Information Technology, Vol. 53, No. 2, 20 July 2013.

[18] G. Ellis, "Observers in Control Systems, A Practical Guide", Academic Press, An Imprint Elsevier Science, The 1st Edition, October 10, 2002.

[19] K. Nabti, K. Abed, H. Benalla, "Sensorless Direct Torque Control of Rushless AC Machine Using Luenberger Observer", Journal of Theoretical and Applied Information Technology, Vol. 4, No. 8, August 2008.

## BIOGRAPHIES



**Adil Essalmi** was born in Taza, Morocco on March 24, 1981. He received with honors the Ph.D. degree in electrical engineering from Mohamadia School of Engineers, Rabat, Morocco in 2016. Since 2018, he has been a Professor of Power Electronics and Electric Drives at Faculty of Sciences, University Sidi Mohamed Ben Abdellah, Fez, Morocco. He has presented papers at national and international conferences on the electrical machines, power electronics and electrical drives. His current area of interest is related to the innovative control strategies for AC machine drives, renewable energy.



**Hassan Mahmoudi:** was born in Meknes, Morocco on January 4, 1959. He received the B.S degree in electrical engineering from Mohammadia School of Engineers, Rabat, Morocco in 1982, and the Ph.D. degree in power electronic from Montefiore Institute of Electrical Engineering, Luik, Belgium in 1990. He was an Assistant Professor of Physics, at Faculty of Sciences, Meknes, Morocco, from 1982 to 1990. Since 1992, he has been a Professor at Mohammadia School of Engineers, Rabat, Morocco, and he was the Head of Electric Engineering Department during four years (1999, 2000, 2006 and 2007). His research interests include static converters, electrical motor drives, active power filters and the compatibility electromagnetic.



**Aziz El Janati El Idrissi** was born in Taounat, Morocco in January 1979. He received with honors the Ph.D. degree in electrical engineering from Faculty of Sciences, Rabat, Morocco in 2017. Since 2018, he has been a Professor in Department of Electrical and Industrial Engineering at National School of Applied, Abdelmalek Essaadi University Sciences, Tangier, Morocco. He has presented papers at national and international conferences on electrical machines, power electronics and electrical drives. His current area of interest is related to the innovative control strategies for AC machine drives, renewable energy.